

NOTES:

- MECHANICAL: MATING FORCE: 5-20N .
UNMATING FORCE: 8-20N .
DURABILITY: 10000 CYCLES MIN.
- ELECTRICAL:
CURRENT: 5.0A MAX
VOLTAGE: 20V MAX
WITHSTANDING VOLTAGE: 100V AC
CONTACT RESISTANCE: 40 mΩ MAX INITIAL;
50 mΩ MAX AFTER 10000 CYCLES
- ENVIRONMENTAL:
OPERATING TEMPERATURE RANGE -30°C ~ +80°C
- Salt Spray: 24H

A1	GND	B12	GND
A2	/	B11	/
A3	/	B10	/
A4	VBUS	B9	VBUS
A5	CC1	B8	SBU2
A6	D+	B7	D-
A7	D-	B6	D+
A8	SBU1	B5	CC2
A9	VBUS	B4	VBUS
A10	/	B3	/
A11	/	B2	/
A12	GND	B1	GND

BOM			
序号	名称	用量	品名规格
1	外壳	1	Typec 16PIN 沉板1.2 外壳 SUS304 T=0.30mm
2	Molding 3	1	Typec 16PIN 沉板1.2 Molding C7025 T=0.15 PA9T黑色 半成品
2.1	Molding 1	1	Typec 16PIN 沉板1.2 Molding A C7025 PA9T黑色
2.2	Molding 2	1	Typec 16PIN 沉板1.2 Molding B C7025 PA9T黑色
2.3	卡勾	1	Typec 16PIN 沉板 卡勾 SUS301 T=0.15mm

ZDX 深圳市兆达鑫科技有限公司
Shenzhen Zhao Xin Technology Co., Ltd.

TOLERANCE: X.X ±0.30 X.XX ±0.20 X.XXX ±0.10 X.XX ±0.10 X.X ±0.05 X ±0.05	DRAWN BY :	DATE :	PART NAME:	
	刘志强	2015.08.18	Type-C 16PIN 沉板1.2 L=6.5mm	
UNIT: mm [inch] SCALE: 1:1 SIZE: A4	CHECKED BY :	DATE :	PART NO.	SEE TABLE
	李毅	2015.08.18	MOLD NO.	
	APPROVED BY :	DATE :	DRAW NO.:	ZDJNKJ00001621
	张少辉	2015.08.18	SHEET NO.	1 OF 1

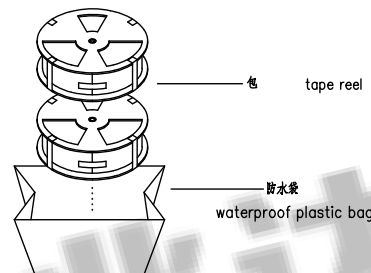
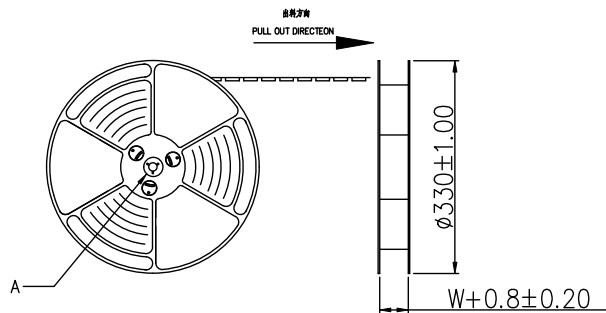

at small positioning hole of the carrier tape side).
 備 (備 包材的小定位孔)

Location of label sticking (label)

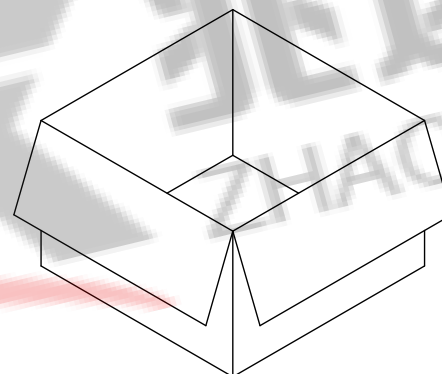
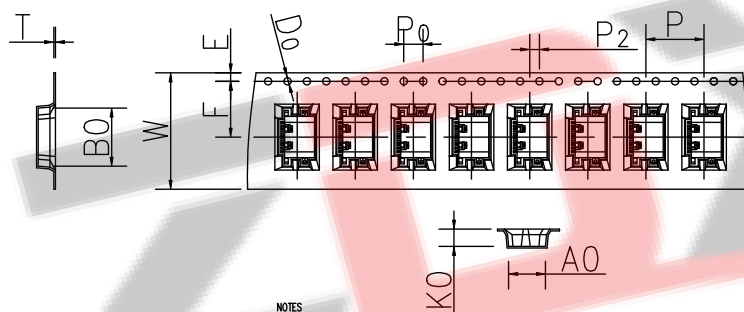
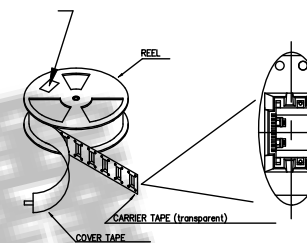

箱: 340mmX340mmX325mm

NOTE:

1. 每包量及每箱箱量如左下表格.

Packing q'ty of each reel & carton as below table shown.

2. 品的卷放入箱并以封口

Put reels in the carton and use adhesive tape to seal up.

NOTES

1. 牙明度
 LEAD TAPE LENGTH
 牙明度
 PULL OUT DIRECTION

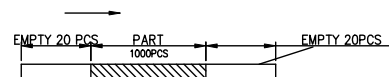

2. 上 牙力 : 0.1~1.3N(10.2gf~130gf)
 PEELING OFF FORCE OF TOP TAPE: 0.1~1.3N(10.2gf~130gf)
 備: 備中一備注:
 THIS REQUIREMENT SHOULD BE APPLIED AT SHIPMENT:
 備: 備中一備注:
 PEELING OFF SHOULD NOT BE ALLOWED DURING TRANSPORTATION

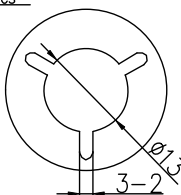
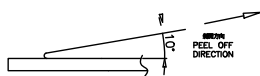

DETAIL: A
 10:1

W	24.00±0.3
A0	7.6±0.1
B0	12.0±0.1
K0	3.55±0.1
P	12.00±0.1
F	11.50±0.1
E	1.75±0.1
D0	1.50±0.1
P0	4.00±0.1
P2	2.00±0.1
T	0.35±0.1

卷带	规格: $\phi 330\text{mm}$	包装数量: 10000PCS
纸箱	规格: 340mmX340mmX325mm	包装数量: 10 盘(10000PCS)

ZDX 深圳市兆达鑫科技有限公司
 Shenzhen Zhao Xin Technology Co., Ltd.

TOLERANCE: X:XX ±0.30 X:XX ±0.20 X:XXX ±0.10 X:· ±10° X:· ±5°	DRAWN BY : 刘志强	DATE : 2015.08.18	PART NAME: Type-C 16PIN 沉板1.2 L=6.5mm
UNIT: mm [inch] SCALE: 1:1 SIZE: A4	CHECKED BY: 李毅	DATE : 2015.08.18	PART NO. SEE TABLE MOLD NO.
	APPROVED BY: 张少辉	DATE : 2015.08.18	DRAW NO: ZDJNKJ00001621 SHEET NO. 1 OF 1