

特性:

一、电气性能: EICTRICAL

1. 额定电流: 5.0A
2. 接触阻抗: 40 MILLIOHMS MAX
3. 耐电压: 100V AC / 1 mA MAX
4. 绝缘阻抗: 150V DC/100 MEGA OHMS MIN

二、机械性能:

1. 插入力: 5~20N
2. 拔出力: 8~20N
3. 使用寿命: 10000次, 拔出力 5N MIN

三、材料: MATERIAL

四、电镀: FINISH

1. 端子: 接触点镀金1U"MIN  
PIN脚焊接区域镀锡80U"MIN
2. 外壳: 镀镍80U"MIN (盐雾48H)
- 五、电镀品需做粘锡测试: 粘锡面积达到95%以上。
- 六、SMT回流焊(峰值260°C±5°C)不能起泡、熔胶、变色不良(变形在公差范围以内)
- 七、工作温度: -55°C~+85°C
- 八、盐雾测试: 通过48H在浓度为5±1%盐水的盐雾测试无生锈现象

A1	A2	A3	A4	A5	A6	A7	A8	A9	A10	A11	A12
GND			VBUS	CC1	D+	D-	SBU1	VBUS			GND
GND			VBUS	SBU2	D-	D+	CC1	VBUS			GND
B12	B11	B10	B9	B8	B7	B6	B5	B4	B3	B2	B1

BOM				
序号	名称	料号	用量	品名规格
1	外壳		1	Typec立插 外壳 SUS304 T=0.30mm
2	Molding 3		1	Typec立插 DIP 16PIN Molding C7025 LCP黑色 半成品
2.1	Molding 1		1	Typec立插 DIP 16PIN Molding A C7025 LCP黑色
2.2	Molding 2		1	Typec立插 DIP 16PIN Molding B C7025 LCP黑色
2.3	卡勾		1	Typec立插 16PIN 卡勾 SUS301 T=0.15mm

**ZDX** 深圳市兆达鑫科技有限公司  
Shenzhen Zhao Xin Technology Co., Ltd.

TOLERANCE: X.XX ±0.30 X.XXX ±0.20 X.XXX ±0.10 X.XX ±0.10 X.X ±0.05 X.X ±0.05	DRAWN BY:	DATE:	PART NAME:	
	刘志强	2015.08.18	TYPE-C16PIN立式贴板H10.0	
UNIT: mm [inch] SCALE: 1:1 SIZE: A4	CHECKED BY:	DATE:	PART NO.	SEE TABLE
	李毅	2015.08.18	MOLD NO.	
	APPROVED BY:	DATE:	DRAW NO.:	ZDJNKJ00001612
	张少辉	2015.08.18	SHEET NO.:	1 OF 1

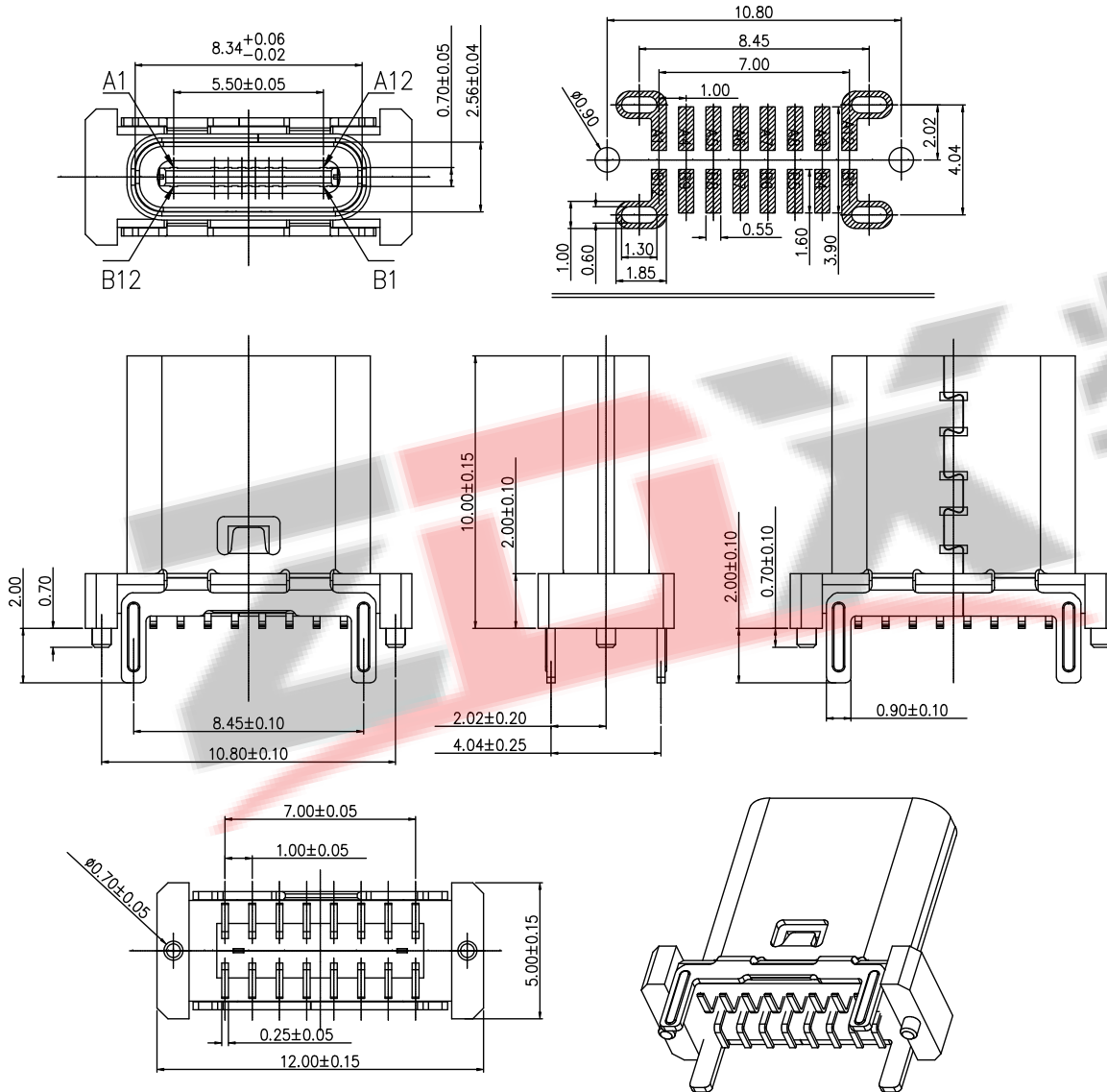

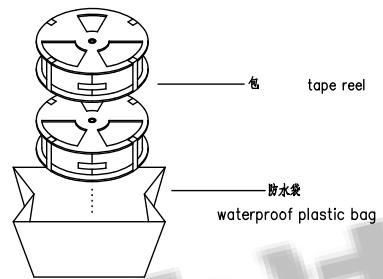
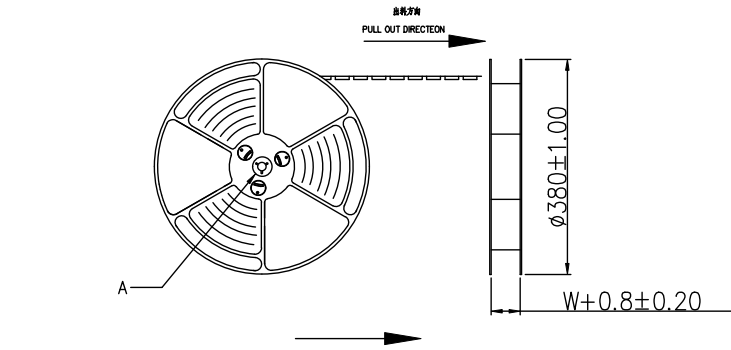

at small positioning hole of the carrier tape side.  
 轴 (轴 与材料小定位孔一)  
 Location of label sticking (label)

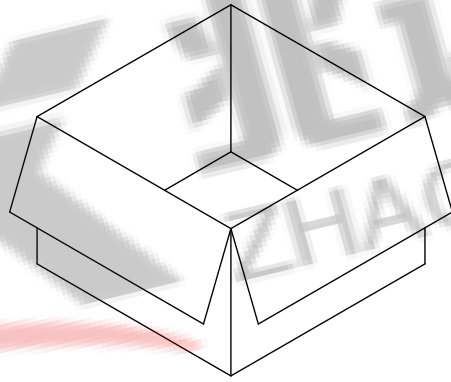
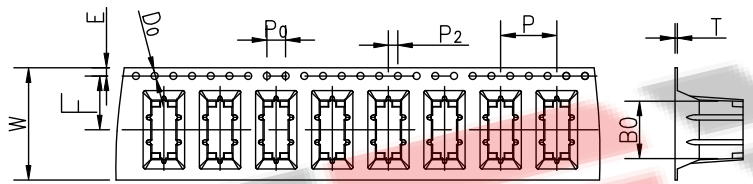
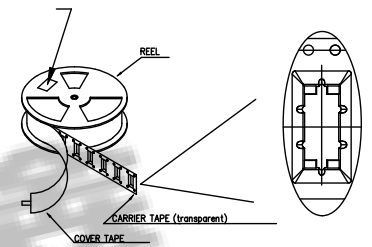

NOTE:  
 1. 每包量及每箱量如左下表格。  
 Packing q'ty of each reel & carton as below table shown.  
 2. 产品的卷放入箱并以封口。  
 Put reels in the carton and use adhesive tape to seal up.

箱: 390mmX390mmX300mm

卷带	规格: $\phi 380\text{mm}$	包装数量: 500PCS
纸箱	规格: 390mmX390mmX300mm	包装数量: 8盘(4000PCS)

W	$24.00 \pm 0.3$
A0	$5.24 \pm 0.1$
B0	$12.30 \pm 0.1$
K0	$14.55 \pm 0.1$
P	$12.00 \pm 0.1$
F	$11.50 \pm 0.1$
E	$1.75 \pm 0.1$
D0	$1.50 \pm 0.1$
P0	$4.00 \pm 0.1$
P2	$2.00 \pm 0.1$
T	$0.50 \pm 0.05$

NOTES  
 1. 字码 度  
 LEAD TAPE LENGTH  
 轴长  
 PULL OUT DIRECTION

2. 上 力:  $0.1 \sim 1.3\text{N}$  ( $10.2\text{gf} \sim 130\text{gf}$ )  
 PEELING OFF FORCE OF TOP TAPE:  $0.1 \sim 1.3\text{N}$  ( $10.2\text{gf} \sim 130\text{gf}$ )  
 品' 操作-免拉线:  
 THIS REQUIREMENT SHOULD BE APPLIED AT SHIPMENT:  
 要在 过程中不能  
 PEELING OFF SHOULD NOT BE ALLOWED DURING TRANSPORTATION

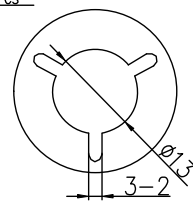
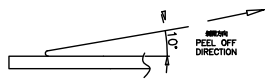

DETAIL: A  
 10:1

**ZDX** 深圳市兆达鑫科技有限公司  
 Shenzhen Zhao Xin Technology Co., Ltd.

TOLERANCE: X.XX ±0.30 X.XXX ±0.20 X.XXX ±0.10 X.X ±10° X.X ±5°	DRAWN BY : 刘志强	DATE : 2015.08.18	PART NAME: TYPE-C16PIN立式贴板H10.0
UNIT: mm [inch] SCALE: 1:1 SIZE: A4	CHECKED BY: 李毅	DATE : 2015.08.18	PART NO. SEE TABLE MOLD NO.
	APPROVED BY: 张少辉	DATE : 2015.08.18	DRAW NO: ZDJNKJ00001612 SHEET NO. 1 OF 1